

SOME IMPLICATIONS OF VARIANT CRANIAL CAPACITIES FOR THE BEST-PRESERVED AUSTRALOPITHECINE SKULL SPECIMENS

GERALD DUFFETT*

Received 9 February 1983

The ten 'best-preserved' specimens of Australopithecine skulls were considered in this present study, which is a survey of the rise and fall in their measured/estimated cranial capacities.

The discovery of 'pre-Zinj' in 1960 probably triggered the change in trend that is detectable in the literature only after that date.

Discrepancies resulting from the basis of the same ten best specimens affect both the 'gracile' and 'robust' forms of Australopithecus africanus whose skulls probably demonstrate sexual dimorphism.

Whilst inadvertently establishing the gender of the Taung child by a mathematical method, the same method suggests that the specimen (Sts. 5) fits the plot of 'robust' results better than that of 'gracile.'

The revised cranial measurements might well imply the following:

- (1) *Evolutionary morphometric studies are so variable as to be unreliable even when based upon the same fossil material.*
- (2) *The revised cranial capacities for australopithecines now lie well within the range of the great apes and so no more warrant the title of 'Near-men.'*
- (3) *If sexual dimorphism explains the presence/absence of the sagittal crest used to identify the 'robust' form as belonging to robustus/boisei species and the 'gracile' form as africanus, then any phylogeny which separates the latter from the former is invalid as it violates the 'facts of life' as well as one definition for the term species.*
- (4) *Discrepant results for cranial capacities such as those for Australopithecus africanus could well explain why phylogenies have recently sought to be established upon molecular studies instead of upon fossil specimens.*

Plan of the Article

Preface

- 1 DATA SOURCES
 - 1.1 Poor presentation
 - 1.2 Taxonomic turmoil
 - 2 SPECIMENS DESCRIBED
 - 2.1 Catalogue numbers
 - 2.2 Species identification
 - 3 SEXUAL DIMORPHISM
 - 3.1 Sagittal crests
 - 3.2 Relative brain size
 - 4 DRASTIC SHRINKAGE
 - 4.1 Discrepancies revised
 - 4.2 Disturbing discovery
 - 5 DATA 'SPIN-OFFS'
 - 5.1 Singular discovery
 - 5.2 Doubtful specimen (Sts.5)
 - 6 DISTURBING SEQUELS
 - 6.1 Theoretical transference
 - 6.2 'Near-men' misnamed
 - 6.3 Futile phylogenies
 - 6.4 Shifting support
- Bibliography (References)
Appendix

Preface

This present study resulted from an excursion into the so-called 'Near-men' whilst researching background material for a tape-slide sequence on the topic of the alleged 'Ape-men.' When delving into details to do with actual specimens, I began to realize something that surely deserves much greater recognition than it has hitherto received. It was that a quiet revolution has taken place regarding the calculation/estimation of *Australopithecus* brain volumes based upon the same ten 'best-preserved' skull specimens. There-

fore, an alternative title could well have read *The Rise & Fall of the Australopithecines*. Certainly it proves the influence of the theory of evolution to bring pressure upon measurements resulting from the same specimens. How else can anyone account for the discrepancies uncovered herein?

Now it must surely follow that if such variation can exist within the scientific literature for the results of studying the best available specimens, then think what twaddle must fill popular books and broadcast programmes when scientists make pronouncements upon very scant fragments of fossil material often found scattered rather than abundant, whole and articulated.

Compared with the specimens of skulls that form the basis of this present study, the remains of 'Lucy' are pathetic. Stuck in a showcase at the British Museum (Natural History) like some holy relic, "Lucy's" lower jaw seems to be having the laugh on any who believe that they are gazing upon the earliest known human ancestor. People who observe the few pieces of its shattered skull will appreciate that there is insufficient to compare its cranial capacity with that of either an ape or a man. So only on an average of ignorance is 'Lucy' (alias *Australopithecus afarensis*) an 'Ape-man' (or 'Ape-woman'). To my mind, 'Lucy' being an australopithecine is A LINK TOO FAR-FETCHED!

1 SOURCES OF DATA

The data about cranial capacities of the best-preserved specimens of Australopithecine skulls are contained in the table on page 48 of *Primate Evolution: an Introduction to Man's Place in Nature*, by Simons. The sources used by Simons are given in an Appendix to this article.

1.1 Poor Presentation

Unfortunately, the significance of the table of data collated by Simons is likely to be overlooked for the following reasons:

*Mr. Gerald Duffett is Head of the Department of Biology, City of Ely College, Ely, Cambridgeshire, England.

2 SPECIMENS DESCRIBED

The data for the cranial capacities shown in Table 1 are based upon 'the ten best preserved brain cases of *Australopithecus*.' As that table contains eleven sets of results, then some explanation is necessary.

2.1 Catalogue Numbers

The first specimen was found by Dart in 1924 and I think that it was never given a museum catalogue number. Certainly none is cited on page 104 of the British Museum (Natural History) *Man's Place in Evolution* published in 1980 by the museum and the Press Syndicate of the University of Cambridge.

The second specimen is really an estimation of the cranial capacity of the adult stage if the first specimen had managed to not die as it is reckoned to have at the age of six years. It is the inclusion of this row in the data that brings the total to eleven in this present study.

The catalogue numbers are shown in the second column of Table 1 for specimens which I have referred to as 3 to 11, inclusively. However, specimen three also bears the reference T.M. 1511 to do with the Transvaal Museum and specimen six is supported by Sts 25.

2.2 Species Identification

Although the main purpose of this present study is to show the variation that can exist even when different workers use the same specimens — in this case the ten best-preserved ones — doubtless to identify to which species a particular specimen belongs will add to its value. Therefore the third column of Table 1 cites which specific epithet accompanies each *Australopithecus* individual.

Of course, strictly speaking, even *robustus* is nowadays considered as being within the *africanus* species of *Australopithecus*. That point was made at the top of the second list in section 1.2 of this present study.

Therefore, a specimen considered to belong to *A. robustus* is frequently referred to simply as a 'robust australopithecine' or a member of the 'robust' form of *A. africanus*. In several sections of this present study (e.g., section 3.1) we shall delve into the significance of the 'gracile' and 'robust' forms of australopithecines.

Owing to "discoverer's bias" already referred to in section 1.2 of this present study, it is obvious that originally the specimens were given different names. For instance, specimen four was called *Plesianthropus transvaalensis*; specimen eight was *Zinjanthropus boisei* and specimen ten was *Paranthropus crassidens*. But on account of the Law of Priority the first-found specimen retains its name and even gives it to the other specimens found later. So specimen one (and therefore specimen two) have always been named *Australopithecus africanus*. Unofficially it has been called 'Dart's baby' after its discoverer and also 'Taung child' after the site where it was found.

3 SEXUAL DIMORPHISM

The idea that sexual dimorphism alone can account for the distinctive features that separate the 'robust' form from the 'gracile' form is worth following up. In fact, specimen number four was affectionately called "Mrs. Ples" owing to two reasons. One was that it was

FIGURE 1 TWO FORMS OF AUSTRALOPITHECINES BELIEVED TO SHOW SEXUAL DIMORPHISM

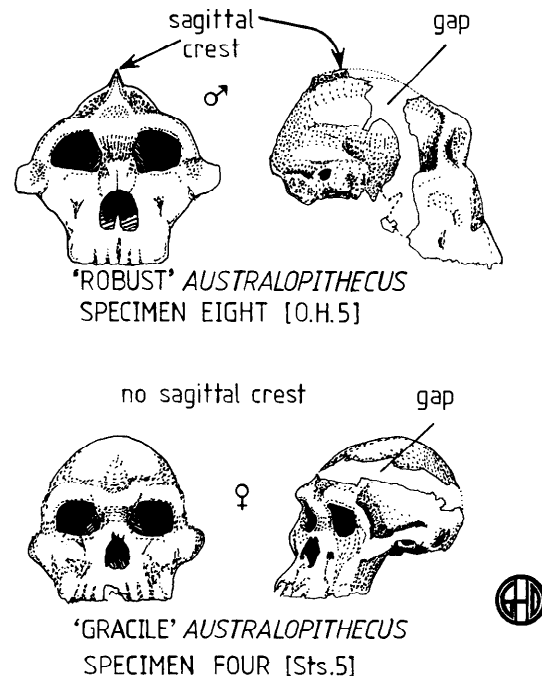

'gracile' and the other was that it originally belonged to the genus *Plesianthropus* as mentioned in sections 1.2 and 2.2 of this present study.

Now it follows that because specimen four which is alleged to be female and is now named *africanus*, then specimens one to seven, inclusive must also be female. Conversely, specimens eight to eleven, inclusive must be male. So, provided that that assumption is correct, then at a stroke we have the sex of each specimen by examining the identified species given in column three of Table 1.

3.1 Sagittal Crests

A glance at Figure 1 will reveal that the male specimen has a keel like ridge running over the top of the cranium. This is termed the sagittal crest and served to provide a greater area for powerful jaw muscles. Correlated with the presence of that crest is the fact that the molars are not only larger compared with skulls having no crest, but also the lower premolars tend to be 'molarized'; that is, they have extra cusps or tend to and so resemble molar teeth.

Obviously the 'robust' form with the sagittal crest possessed masticatory musculature to increase bite pressure. Robinson⁷ thinks that they were herbivorous whereas the 'gracile' form was omnivorous. The anterior teeth of the 'gracile' specimens are on average larger than those of the 'robust' specimens.

In passing, it is interesting to note that whereas the 'gracile' form has a cranium that resembles man's more than the 'robust' form, it is the 'robust' form which possesses canines more closely resembl(ing) canines in later hominids than do those of the 'gracile' specimens:

AUSTRALOPITHECUS AFRICANUS					
CRANIAL [BRAIN] CAPACITIES					
My reference no.	cubic centimetres		Difference	% difference	
	Original	Revised			
1	510	407	-103	-20.2	
2	597½	440	-157½	-26.4	
3	435	415	-20	-4.6	
4	480	485	+5	+1.0	
5	500	428	-72	-14.4	
6	530	436	-94	-17.7	
7	480	435	-45	-9.4	
Totals	3532.5	3046	486.5	-13.8	
Averages	504.6	435.1	69.5	-13.8	

AUSTRALOPITHECUS ROBUSTUS					
CRANIAL [BRAIN] CAPACITIES					
My reference no.	cubic centimetres		Difference	% difference	
	Original	Revised			
8*	530	530	0	0	
9	530	530	0	0	
10	750	500	-250	-33.3	
11	800	500	-300	-37.5	
Totals	2610	2060	-550	-70.8	
Averages	652.5	515	137.5	-21.1	

*Australopithecus robustus boisei

TABLE 2 ANALYSED DATA

they are more conical and the crowns lack the asymmetry seen in the teeth from Sterkfontein.

Whereas only the male sex of orang-utans and gorillas possess a sagittal crest, it is a sober thought that none exists in chimpanzees. So the idea of being able to sex specimens of fossil apes on the basis of the presence/absence of a keeled cranium may prove to be an oversimplification of the case. Already the first signs of future complications is the claim by Wolpoff⁸ to have demonstrated sexual dimorphism within the 'gracile' sample.

Before leaving the subject of sagittal crests it is perhaps pertinent to note that a slight trace exists in male Eskimoes. In other words, it occurs in the males of one race of *Homo sapiens sapiens*, which is enough to

question the validity of mankind being descended from chimpanzees.

3.2 Relative Brain Size

The ratio of brain volume to body weight is termed relative brain size. The formula is as follows:

$$\text{Relative Brain Size} = \left[\frac{\text{Cranial Capacity in cc.}}{\text{Body Weight in g.}} \right] \times 100.$$

Harrison and Montagna⁹ reckon that australopithecines weighed between 40 and 50 lb. So I am assuming that the 'robust' (males?) weighed an average of 47½ lb. and the 'gracile' (females?) weighed an average of 42½ lb.

Using the data shown in Table 2, it is then possible to try and calculate the relative brain size for each specimen on the basis of revised cranial capacity and average body weight which is 19278 g. for *affricanus* (females?) and 21546 g. for *robustus* (males?), respectively.

Figure 2 shows the plot of cranial capacities against relative brain sizes for each form of australopithecine.

Incidentally the relative brain size for an 18 year man having an average body weighing 63.05 kg is 2.379 and that for a woman of the same age having an average body weighing 54.39 kg. is 2.482. Of course once anyone puts on weight, his relative brain size diminishes. That probably explains why Schultz¹⁰ calculated man's as 2.02 compared with 1.94 for a gibbon's. Compared to which the average australopithecine specimen yielded a relative brain size of 2.325.

In passing, it is good to be reminded that even the relative brain size is not a foolproof parameter to verify humanity as the squirrel monkey (*Saimiri orstedii*) has a score of 2.97!

4 DRASTIC SHRINKAGE

Whatever complications may obscure simple methods of sexing specimens or even identifying them as species on the sole basis of their skulls and particularly by only their crania, it still holds true that the main purpose of this present study is to draw attention to the existence, extent and direction of the discrepancies in assessing the cranial capacities of the same ten 'best-preserved' specimens of australopithecines. The underlying reason will be considered.

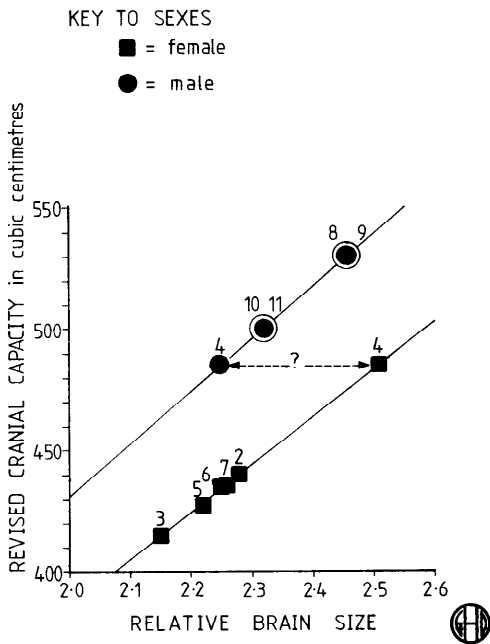

FIGURE 2 PLOT OF AUSTRALOPITHECUS AFRICANUS SPECIMENS TO INVESTIGATE SEXUAL DIMORPHISM OF CRANIA AND TO QUESTION THE SEXUAL IDENTITY OF SPECIMEN 4 [Sts.5]

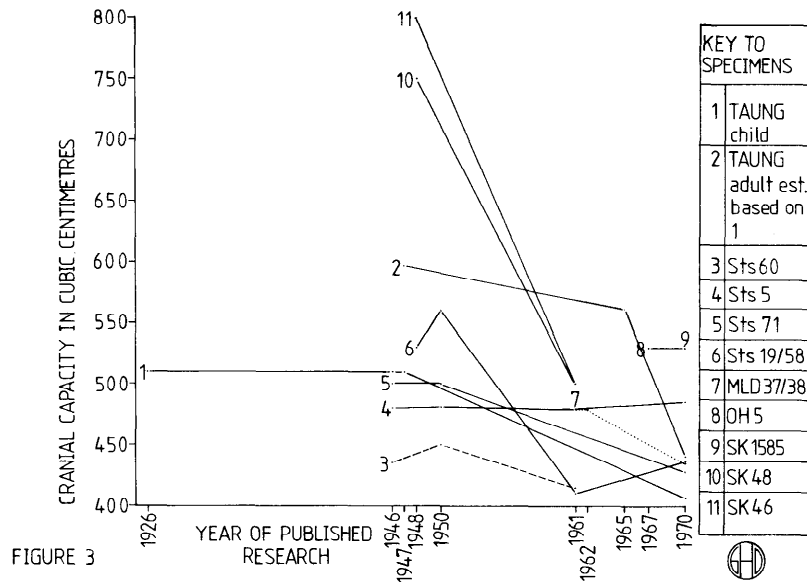

FIGURE 3

4.1 Discrepancies Revised

Figure 3 shows the data of Table 1 plotted as cranial capacity in cubic centimetres with year of published research. A glance at that figure will reveal that nothing much happened to cranial capacities between 1926 and 1945, but in 1946 other specimens were measured. Therefore, Figure 4 concentrates upon the period between 1946 and 1970 (inclusively). Also, in order to spot the direction and extent of revisionary trends the cranial capacities are plotted in terms of the percentage difference (if any) per box as shown in italics in Table 1. The first details of volume in c.c. is termed the original volume on the vertical axis of figure 5 and the final details of volume in c.c. is termed the revised volume on the vertical axis of figure 6.

Although specimens three, four, five and six showed some rise (i.e., increased calculated result for cranial capacity) only specimen four ended with a final volume of 485 c.c. (a 1% increase compared with the original volume) whereas the other specimens showed final volumes much less than the original volumes. Specimen three came to 20 c.c. less (a drop of 4.6%); specimen five dropped by 72 c.c. (a drop of 14.4%); and specimen six 'shrank' by 94 c.c. (a drop of 17.7%).

Out of the specimens that showed no sign of any revisionary rise in cranial capacity volume, specimen one fell by 103 c.c. (a drop of 20.2%) and also this affected the rating of the adult cranial capacity for this specimen which I have listed as specimen two. That fell by 157½ c.c. (a drop of 26.4%). But, whereas specimen seven showed a shrinkage of 45 c.c. (a drop of 9.4%) specimens ten and eleven gave drastic reductions. The former dropped 250 c.c. in size (a 33.3% reduction) and the latter dropped 300 c.c. in size (a record reduction of 37.5%)!

Overall the revisionary calculations of australopithecine skulls have led to reductions of their calculated volumes. The total percentage differences amount to -157.9!

4.2 Disturbing Discovery

Having established the nature of the discrepant data for the best-preserved australopithecine skulls, it still remains to suggest a reason for two phenomena. The first phenomenon must surely be the fashionable trend to over-emphasize the volume of each specimen when originally measured. Then the second phenomenon must be the dramatic reduction that is evident when the original and final volumes are compared.

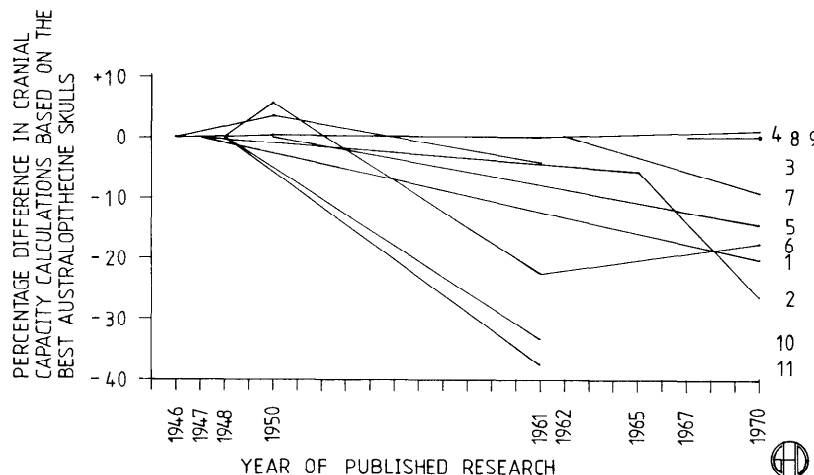

FIGURE 4

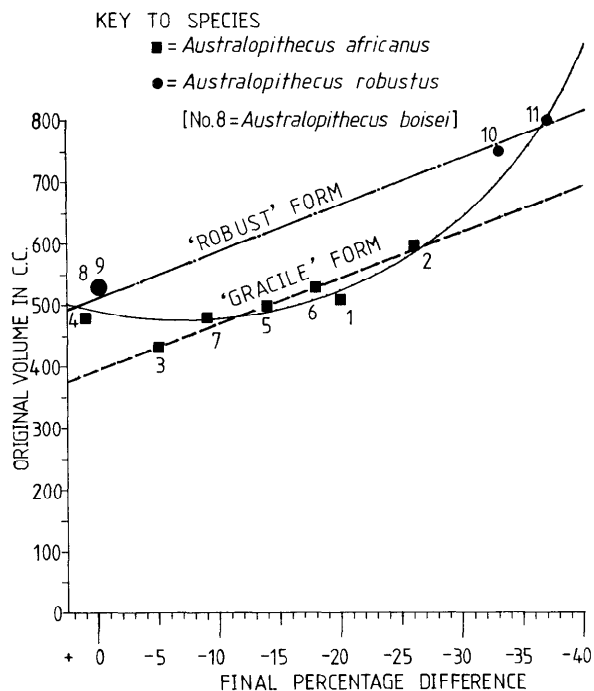

FIG.5 REGRESSION ANALYSES OF PLOT FOR VARIANT CRANIAL CAPACITIES OF AUSTRALOPITHECINE SPECIMENS SORTED INTO SPECIES

Now, remembering that in the popular mind (and subconsciously in the scientific mind) cranial capacity in primates is equated with intelligence, then the reason for the pseudoinflationary estimates of australopithecine cranial capacities could well lie in “discoverer’s pride.” On the grounds that the larger the cranial capacity, the larger is the brain that it used to enclose. So the tendency to be generous towards the specimen was really to claim for it a better place in the quest for fossil evidence of the proverbial ‘ape-man.’

In 1946, the calculations based upon specimens three, four and five were modest, yet only specimen four proved to be an original underestimation. But the scores given in 1948 for specimens six, ten and eleven were way-out! Could it be that specimen six was made to look bigger than those of 1946 yet the author was ignorant of the high estimation based on the Taung child as an adult in 1947? Surely only “discoverer’s pride” can account for the cranial capacities ascribed to specimens ten and eleven. If they were rising house prices, then a “Dutch auction” technique would have been suspected!

Then in 1950 — apart from specimen five’s rating that remained the same — the rating for all of the other specimens (viz., three, four and six) showed modest increases. But in 1961 the revised estimates for each specimen showed a reduction when compared with the foregoing estimates except for specimen seven for which no previous estimate had been calculated. Thereafter the general trend is for further reductions compared with just one specimen showing a 1% increase.

The only clues the data give about the underlying reason for the dramatic switch of trends resulting in some instances of revisions producing drastic reductions are as follows:

SPECIMENS	DATES OF PUBLISHED RESEARCH										
	My ref	(1926)	(1946)	(1947)	(1948)	(1950)	(1961)	(1962)	(1965)	(1967)	(1970)
1	√	=	=							▼	▼
2				√					▼		▼
3		√				▲	▼				
4		√				▲	▼				▲
5		√				=					▼
6				√		▲	▼				▲
7							√	=			▼
8									√	=	
9											√
10					√		▼				
11					√		▼				

No. =	1	1	1	1	1	1	5
No. UP				3			2
No. DOWN					5	1	4

TABLE 3 EVIDENCE OF A CHANGE OF MIND ABOUT BRAIN VOLUMES OF THE BEST PRESERVED SKULLS OF AUSTRALOPITHECUS SPECIMENS AT SOME TIME BETWEEN 1950 & 1961

Key to symbols
 √ 1st measurement = same as former
 Revised value is
 ▲ up/down 1-29c.c.
 ▼ up/down 30-300cc.

- (1) The reason occurred some time after the preparation of the 1950 publication.
- (2) The reason occurred before the 1961 publication.
- (3) If the reason caused the 1961 publication, then it might well have occurred in the previous year.
- (4) The reason resulted in what amounted to mathematical rather than physical ‘head-shrinking’ of the australopithecine specimens (actually involving the ten ‘best-preserved skulls!’).
- (5) The reason (whatever it was) certainly stopped the inflationary trend dead in its tracks.
- (6) Therefore the reason must have made it clear to evolutionists that there was no longer any value in believing that australopithecines with large heads gave rise to mankind.

My reference number for specimens	Original volume’s position	Revised volume’s position	Positional difference
1	7	11	down 4
2	3	6	down 3
3	11	10	up 1
4	9	5	up 5
5	8	9	down 1
6	4	7	down 3
7	9	8	up 1
8	4	1	up 3
9	4	1	up 3
10	2	3	down 1
11	1	3	down 2

TABLE 4 SPOTLIGHTING INCONSISTENT TREATMENT OF AUSTRALOPITHECINE CRANIAL CAPACITIES

- (7) The reason most likely was another fossil discovered to have a cranium more in keeping with the shape of an ancestor for mankind but not as large as the inflated ratings already existing in scientific publications.

Now the only fossil that fits perfectly as an explanation for the fall after the previous rise in australopithecine cranial capacities is "*Homo habilis*" found in 1960 by Dr. L. S. B. Leakey.¹¹ It was at first hailed as 'pre-Zinj.' Alternatively its familiar name is "Handy Man" on account of a bone tool reckoned to have been a lissoir used in leatherwork.

The aforementioned up and down trends are depicted in the contents of Tables 3 & 4. Also the two slightly increased revised cranial capacity measurements for specimens four and six shown in the 1970 column indicate an eighth clue to check my contention that the discovery of 'pre-Zinj' was the key fact that supported evidence of man's ancestry better than the (other) australopithecines, e.g., *Australopithecus boisei* or *Zinjanthropus boisei* which was named "East Africa Man" and was reckoned to have a cranial capacity of 530 c.c. For specimens four and six in 1970 were rated as having scores of 485 c.c. and 436 c.c., respectively. They certainly presented no challenge to 'pre-Zinj' which Tobias¹² calculated to have a possible range of between 642.7 c.c. to 723.6 c.c. giving an average value of 680.8 c.c. for its cranial capacity.

A final clue that springs to mind is that the score for 'pre-Zinj' not only had to be larger than those of any australopithecine skull's cranium, but also it must at the same time be smaller than the smallest known *Homo erectus* cranial capacity which according to Tobias was 775 c.c.

5 DATA 'SPIN-OFFS'

Although the main purpose of this present study has been fulfilled by the data analyzed in sections 4.1 and 4.2, respectively, two items of peripheral importance should be mentioned before drawing conclusions. Both concern some of the plots shown in Figures 2, 5 and 6 and are best dealt with separately.

KEY TO SPECIES

- = *Australopithecus africanus*
- = *Australopithecus robustus*
- [No. 8 = *Australopithecus boisei*]

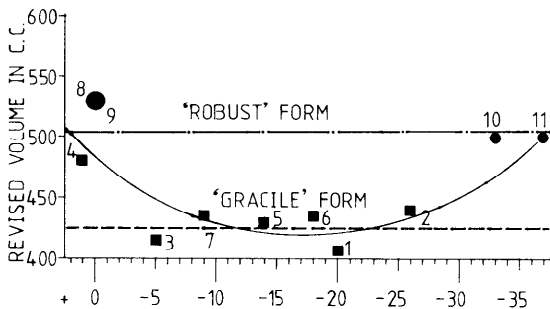

FIGURE 6 FINAL PERCENTAGE DIFFERENCE REGRESSION ANALYSES OF PLOT FOR VARIANT CRANIAL CAPACITIES OF AUSTRALOPITHECINE SPECIMENS SORTED INTO SPECIES



5.1 Singular Discovery

Specimen one was described as the Taung child or Dart's baby, so it might be imagined that no attempt was possible to decide upon its sex. Yet that is not the case. In Fig. 2 whilst it does not exist as specimen one, it is plotted as the estimated adult cranial capacity termed by me 'specimen two.' There it exists definitely on the regression line with all the other female specimens.

Similarly, as specimen one the Taung child exists much closer to the regression line for the 'gracile' (=female?) form identified as *Australopithecus africanus* than compared with the 'robust' (=male?) form identified as *Australopithecus robustus*.

5.2 Doubtful Specimen (Sts. 5)

Having apparently solved one mystery in section 5.1, a new one is only now showing itself within Figures 2, 5 and 6. It is the identity of specimen four in this present study. In the scientific world it is registered as Sts. 5.

Although it is listed in Tables 1 and 2 as being *Australopithecus africanus*, that is a 'gracile' form: a niggling doubt remains about whether it is really from a female individual.¹³

Not only was it the only specimen of the 'ten best-preserved specimens' of australopithecines to show a final volume increase in its cranial capacity, which is better visible on Figure 4 than compared with Figure 3, but also it occupies an anomalous position in Figures 5 and 6 because it lies much closer to the regression line drawn through the plot of other 'robust' form specimens than it does to that of 'gracile' form specimens.

Therefore, in view of the above mathematical contraindications of the sexual status (hitherto accepted) for Sts. 5, I have shown its position plotted both as a male with the 'robust' forms and as a female with the (other) 'gracile' forms in Figure 2. There, although the specimen fits on both regression lines, as a male its position is closer to the position of the plots of the other males than on the other line where it distances itself from the other females.

But before resting my case on what is very peripheral to the main point of this present study I notice from photographs and line drawings of australopithecine skulls in the British Museum (Natural History) guidebook entitled *Man's Place in Evolution* (1980) that the top of the cranium is nowhere materially attached to the rest of the specimen's skull. So anyone who doubts that Sts. 5 originally had a sagittal crest on its skull top could well be 'talking out of the top of his head!'

6 DISTURBING SEQUELS

In this present study I am not accusing any palaeontologist involved in the finding and measurement (or estimation) of the ten 'best-preserved' cranial capacities of the fossil material known as australopithecine skulls of 'skulduggery' or of conscious falsification. Rather, I wish to point out some facets of this survey which arise as implications. The one thing that each implication has in common with the australopithecine fossils is the common goal to support the theory of evolution — to plot out its allegedly prehistoric route irrespective of finally knowing its mechanism.

6.1 Theoretical Transference

Not only does 'discoverer's pride' play some part in raising the status of a specimen nearer to the discovery of a veritable 'ape-man,' but also institutions survive on funds and, I suspect, that as in editing small changes are made, then almost inevitably co-workers within the same institution gather around material and express opinions which imply that their laboratory is handling the very best in fossil-ware.

When looking at the face it is obvious that little can be done to 'reconstruct' the muzzle-like jaws, and anyway the public have learned to expect ape-like jaws for an 'ape-man,' but the skull cranial bones are invariably fragmented and seldom fit as properly as 'jig-saw puzzle pieces' would, so there is scope for slightly (perhaps imperceptibly and subconsciously) leaving a gap between each piece to represent the edge of the bone that time (reckoned in millions of years!) has worn away. In such a way a cranium is reconstructed that does not obviously violate the geometry of the domed pieces.

What this present study has shown is that in order to provide evidence for the change of one species into another, the size of the ten 'best-preserved' specimens was altered in two ways. First there tended to be an upward trend. The discovery of specimens ten and eleven were put at 750 c.c. and 800 c.c., respectively, by scientists who were in effect saying 'My specimen's conk is bigger than your specimen's conk!' Thus the mentality of schoolboys playing 'conkers' was carried into the study of human evolution (alias physical anthropology and hominid phylogeny) and all because of the 'Yuri Geller effect' of the theory of evolution upon the fossil material transmitted through the fingertips and thought processes of the workers.

That the above explanation is close to the facts of the case of the variant and discrepant cranial capacities for australopithecines may be confirmed by a fact of twentieth century history. It is that as soon as 'pre-Zinj' was discovered in 1961 which meant that inflationary estimates had been backing the wrong horse in the race of evolution, then and only then did revisionary reductions of cranial capacity volumes occur.

Whilst it is a fact of life that biological material shows variation when one specimen is compared with another, each specimen does not vary — certainly nowhere as much as those best ones that form the main theme of this present study.

Only during the process of birth does nature allow brainboxes to survive the experience of being treated as 'squeeze-boxes': a situation far removed from museum laboratories!

6.2 'Near-Men' Misnamed

The revised cranial capacities of the australopithecine specimens that form the main part of this present study show nothing greater than 530 c.c. Therefore, the upper limit of endocranial volume of all *Australopithecus* species is no longer standing at 800 c.c. (e.g., specimen eleven SK 46) as once it did. So it follows that any book on the subject of human palaeontology published before the 1960s must be out of date in at least two respects. One is that it was written before the discovery of 'pre-Zinj' and the other is that it

would be oblivious of the drastic reductions in calculations/measurements/estimations regarding the ten specimens included in this present study.

Yet Simons omitted to mention head-shrinking that has occurred in regard to the australopithecines in the assessment quoted from page 4 of *Primate Evolution: an introduction to man's place in nature* as follows:

Because of many new finds, as well as new dates for previously known fossils, most books on this subject published before the 1960s are now out of date.

Although on page 278, Simons conceded that:

The hypothesis that brain enlargement marked the beginning of man was long popular, but went out of fashion with the discovery that the endocranial volumes of the australopithecine group were not larger than those of gorillas.

Previously, on page 276, he still maintained that:

Australopithecus africanus, *A. habilis*, *Paranthropus robustus* or *Zinjanthropus boisei* whether tool-makers or not can be styled adequately by the popular term "near-men."

Now I believe that one implication of this present study is that no australopithecine should be regarded nowadays as 'near-man' when cranial capacity reduction places that group well within the range of apes. Therefore, I believe there is more sense in calling them 'near-apes' — certainly no longer 'near-men'! Such a term is simply a misnomer based upon wishful thinking.

6.3 Futile Phylogenies

Knowing that the 'robust' forms and 'gracile' forms are now reckoned to be the male and female sexes, respectively, then the phylogenies shown in Figure 7 are clearly inaccurate. They neither do justice to the basic 'facts of life' nor to the definition of the term species.

The first one purports to show cladogenesis (= branching evolution). In effect it claims that the common ancestor of man was hermaphroditic which diverged to form the male only branch leading to *A. robustus* and *A. boisei* whilst the main trunk that was entirely female being *A. africanus* led on to *Homo* (man).

The second one purports to show anagenesis (= transformation of one species into another without involving branching). In effect it claims that the common ancestor produced only the female sex amongst its offspring identified as *A. africanus* for many generations over thousands of years until only males were born, which somehow produced other males as offspring. These were named *A. robustus* and after further generations and many years they transformed to give rise to *Homo* (mankind) which we know exists as two sexes.

The third is a variation of the first scheme but showing that the females gave rise by a side branch to the males. In other words, the *A. africanus* gave rise to *A. robustus/boisei* before another side branch produced more females (i.e., *A. africanus*) whilst the main trunk led on by anagenesis to give rise to *Homo*.

Still other schemes exist in the literature. One of them shows an unidentified common ancestor fanning out to produce four lines. The first are the males (*A.*

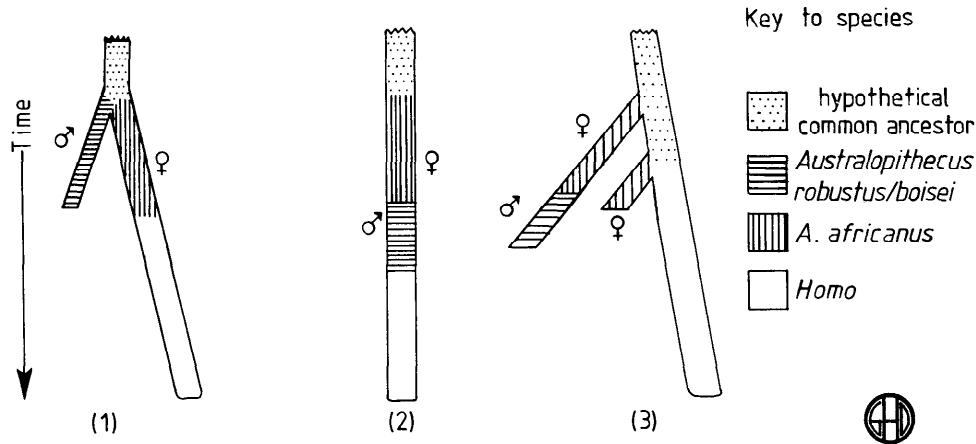

FIGURE 7 PHYLOGENIES THAT ARE INVALID BECAUSE THEY VIOLATE THE 'FACTS OF LIFE'

robustus/boisei); the second are the females (*A. africanus*); the third is *Homo erectus*; and the fourth shows *Homo habilis* (alias 'pre-Zinj') leading on to *Homo sapiens* (so-called 'modern man'). A further scheme places the usual australopithecine sexual nonsense as a side branch from the main trunk leading from their common ancestor anagenetically through *Homo habilis* (alias 'pre-Zinj') on again through *Homo erectus* and then finally culminating in *Homo sapiens* (present-day mankind).

As a further variation of the mistakes shared by all of the above phylogenies is the desire of authors to depict the naked body clothing the fossil's skeleton. For instance, *Australopithecus africanus* is illustrated as a male (!) on page 54 of *The Evolution of Early Man* by Wood.¹⁴

6.4 Shifting Support

The discovery of 'pre-Zinj' toppled the status of the other *Australopithecus* spp. from their position in the early evolution of mankind — at least in alleged schemes. Now that their swollen heads have been reduced to their proper size, *A. africanus* fossils represent simply an extinct form of 'Southern Ape' as their generic name implies.

Therefore, with heads shrunk smaller than those of present-day apes, the new quest for man's evolutionary relationship (if it ever exists) is along the lines of comparing the sequence of amino acids within certain proteins as well as by comparing the sequence of bases along the length of the DNA molecules of man and great ape.

Is it too much to believe that when the ten 'best-preserved' australopithecine skulls were revised which resulted in their reduced cranial capacity, then that caused such a revolution in palaeontology that the evidence for evolution has shifted to biochemistry because the fossil bones were check-mating attempts to support human evolution with australopithecine morphometrics?

References

1. Simons, Elwyn L., 1972. Primate evolution: an introduction to man's place in nature. Macmillan. P. 270.
2. Savage, J. M., 1977. Evolution, third edition. Holt, Rinehart, and Winston, London. P. 168.
3. Zimmerman, P. A., 1970. Rock strata and the Bible record. Concordia Publishing House, London. P. 167.

4. Wood, B. A., 1978. Human evolution. Chapman and Hall, London. Pp. 38 & 49.
5. Broom, R., and J. T. Robinson, 1949. A new type of fossil man. *Nature* 164(4164):322-323.
6. Clarke, R. J., F. C. Howell, and C. K. Brain, 1970. More evidence of an advanced hominid at Swartkranz. *Nature* 225(5239):1219-1222.
7. Robinson, J. T., 1972. Early hominid posture and locomotion. University of Chicago Press.
8. Wolpoff, M., 1976. *Curr. Anthropol.* 17, 579-606.
9. Harrison, R. J., and W. Montagna, 1973. Man, second edition. Prentice-Hall, P. 64.
10. Schultz, A. H., 1950. The physical distinctions of man. *Proceedings of the American Philosophical Society*, 94(5): 428-449. Reprinted in Howells, W., 1962. Ideas on human evolution. Harvard University Press.
11. Leakey, L. S. B., 1960. Recent discoveries at Olduvai Gorge. *Nature* 188(4755):1050-1052.
12. Tobias, P. W., 1964. The Olduvai bed I hominid with special reference to its cranial capacity. *Nature* 202(4927):4.
13. Sts. 5 perhaps is either a hydrocephalous female or a microcephalous male. De Wit, Duyvenne, 1963. The paleontological record and the origin of man (privately published), p. 24, suggested that the Australopithecines might represent a race of Homo suffering from microcephaly!
14. Wood, B., 1976. The evolution of early man. Published by Peter Lowe. P. 54.

Appendix: Sources used by Simons

- Broom, R., 1950. The genera and species of the South African ape-men. *Transvaal Mus. Mem.* 2, 1-153.
- Broom, R., and J. T. Robinson, 1948. Size of the brain in the ape man *Plesianthropus*. *Nature* 161(4090):438.
- Dart, R. A., 1962. Taungs and its significance. *Natural History* 26, 315-327.
- Dart, R. A., 1962. The most complete *Australopithecus* skull from the pink breccia at Makapansgat. *Actes IV Congr. Panaf. Prehist. Etude Quat.* 40, 337-340.
- Holloway, R. L., 1970. Brain evolution in the *Hominoidea*. Aldine, New York.
- LeGros Clark, W. E., 1970. Observations of the anatomy of the fossil *Australopithecinae*. *J. Anat.* 81, 1-35.
- Robinson, J. T., 1961. The australopithecines and their bearing on the origin of man and of stone tool making. *S. Afr. J. Sci.* 57, 3-16.
- Robinson, J. T. Personal communication with E. L. Simons.
- Schepers, G. W. H., 1946. The South African fossil ape men. Part II. *Transvaal Mus. Mem.* no. 2, 155-272.
- Tobias, P. V., 1965. Early man in East Africa. *Science* 149(3679):22-33.
- Tobias, P. V., 1967. General questions arising from some Lower and Middle Pleistocene hominids of the Olduvai Gorge, Tanzania. *S. Afr. J. Sci.* 63, 41-48.
- Tobias, P. V., 1967. Olduvai Gorge, volume 2, ed. L. S. B. Leakey. Cambridge University Press.
- Many of these references themselves contain bibliographies.